

Fellowes

Office Comb Binder

Quasar+ 500™



Please read these instructions before use.
Do not discard: keep for future reference.

Lire ces instructions avant utilisation.
Ne pas jeter : conserver pour référence ultérieure.

Lea estas instrucciones antes de usarlo.
No las deseche: guárdelas para tenerlas como referencia.

Diese Anleitungen vor Gebrauch genau durchlesen.
Bitte nicht entsorgen: zur späteren Bezugnahme aufheben

Prima dell'uso, si raccomanda di leggere questo manuale di istruzioni. Conservare il manuale per consultarlo secondo le necessità.

Dese instructies voor gebruik lezen. Niet weggoien, maar bewaren om later te kunnen raadplegen.

Läs dessa anvisningar innan du använder apparaten.
Släng inte bort, behåll för framtida bruk.

Læs venligst denne vejledning før anvendelse.
Bør ikke bortskaffes. Behold for fremtidig henvisning.

Lue nämä ohjeet ennen käyttöä.
Älä hävitä: säilytä myöhempää käyttöä varten.

Vennligst les nøye igjennom denne bruksanvisningen før bruk.
Ikke kast den: Ta vare på den for senere referanse.

Przed użyciem proszę zapoznać się z tą instrukcją.
Nie wyrzucać - zachować jako źródło informacji na przyszłość

Перед началом эксплуатации обязательно прочтите данную инструкцию.
Не выбрасывайте данную инструкцию: сохраните ее для последующего использования.

Παρακαλείσθε να διαβάσετε αυτές τις οδηγίες πριν χρησιμοποιήσετε το προϊόν.
Μην τις απορρίψετε: κρατήστε τις για μελλοντική αναφορά

Kullanmadan önce lütfen bu talimatları okuyun.
Atmayın: ileride başvurmak üzere saklayın.

Před použitím si přečtete tyto pokyny.
Nelikvidujte: uschovejte pro budoucí použití.

Pred použitím si prečítajte tieto pokyny.
Nezahadzujte: odložte pre budúce použitie.

Kérjük, hogy használat előtt olvassa el az utasításokat!
Az utasításokat ne dobja ki; tartsa meg referenciaanyagként való jövőbeni használatra.

Leia estas instruções antes da utilização.
Não as deite fora: conserve-as para consulta futura.

Pročitajte ove upute prije upotrebe.
Nemojte baciti: sačuvajte za buduću upotrebu.

Molimo da ova uputstva pročitate pre upotrebe.
Nemojte ih baciti: sačuvajte ih za ubuduće.

Моля, прочетете тези инструкции преди употреба.
Не изхвърляйте: пазете за справки в бъдеще.

Vã rugãm sã citiți aceste instrucțiuni înainte de utilizare.
Nu aruncați: păstrați pentru o consultare ulterioară.

Pred uporabo preberite ta navodila.
Ne zavržite: shranite za poznejšo uporabo.

برجى الاطلاع على الإرشادات قبل الاستعمال.
لا يجب التخلص من هذه الإرشادات. ويرجى حفظها للرجوع إليها في المستقبل.

נא לקרוא הוראות אלה לפני השימוש.
אין להשליך: שמרו לעיונכם בעתיד.

ENGLISH

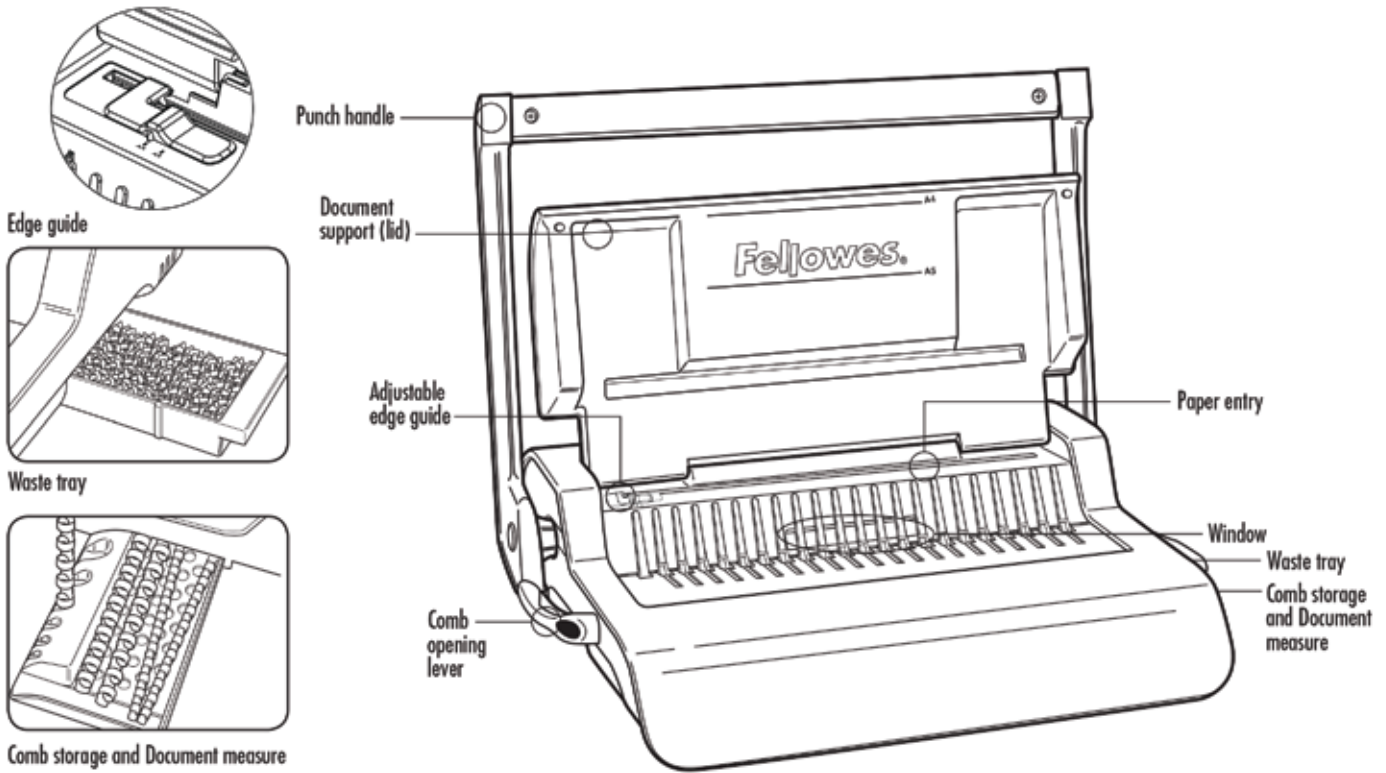

CAPABILITIES

Punching Capacity

Paper sheets	
80g / 20lb	25 sheet
Transparent covers	
100-200 micron / 4-8 mil	3 sheet
200+ micron / 8+ mil	2 sheet
Other standard covers	
160-270g / 40-60 lb	3 sheet
270+g / 60+ lb	2 sheet
Waste tray capacity	approx. 1500 sheet

Binding Capacity

Max comb size	50mm
Max document (80g / 20lb)	500 sheet

Technical Data

Paper dimensions	A4
Punching slots	21
Slot pitch	14.28mm / 9/16"
Adjustable edge guide	yes
Net weight	7 kg / 15.4 lb
Dimensions (HxWxD)	130 x 390 x 460mm / 5.1" x 15.4" x 18.2"

IMPORTANT SAFETY INSTRUCTIONS



Read Before Using!

Please keep for future reference.

When punching;

- always ensure the machine is on a stable surface
- test punch scrap sheets and set the machine before punching final documents
- remove staples and other metal articles prior to punching
- never exceed the machines quoted performance

Need Help?

Customer Service....
www.fellowes.com
 Let our experts help you
 with a solution.
 Always call Fellowes
 before contacting
 your place of purchase.

COMB DIAMETER & DOCUMENT SIZES

Comb diameter sizes

mm	inch	number of pages
6mm	1/4"	2-20
8mm	5/16"	21-40
10mm	3/8"	41-55
12mm	1/2"	56-90
16mm	5/8"	91-120
19mm	1 1/16"	121-150
22mm	7/8"	151-180
25mm	1"	181-200
32mm	1 1/4"	201-240
38mm	1 1/2"	241-340
45mm	1 3/4"	341-410
51mm	2"	411-500

SET UP

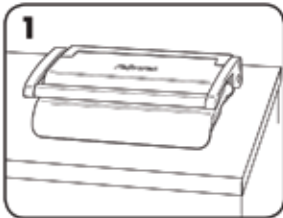

1. Ensure the machine is on a stable surface.

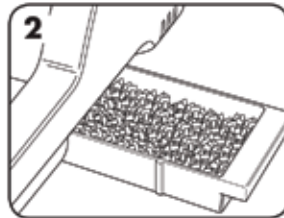

2. Check waste tray is empty and correctly fitted.



3. Lift the lid. Ensure the comb-opening lever is pushed backwards.



4. Lift the punch handle to its upright position.

BEFORE YOU BIND

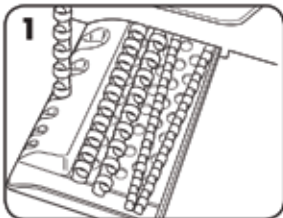

1. Select the correct comb diameter using the comb storage tray.

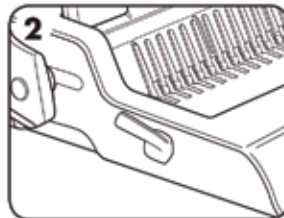

2. Insert the plastic comb into the mechanism.

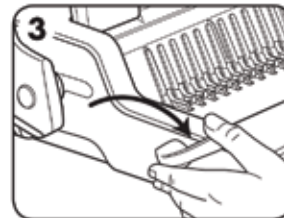

3. Pull comb-opening lever forward to open the comb.

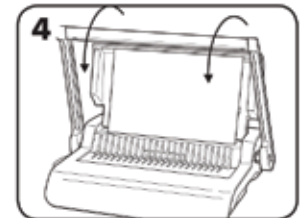

4. Test punch scrap sheets to check edge guide setting.

STEPS TO BIND

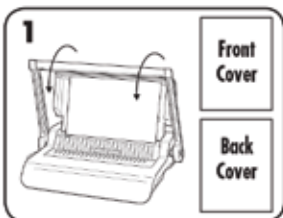

1. Ensure edge guide is set to the proper document size. Punch front and back covers first.

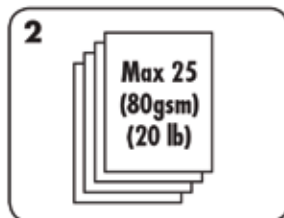

2. Punch sheets in small batches that do not overload the machine or the user. Adjust edge guide, if necessary.

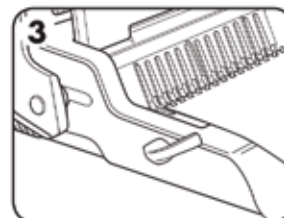

3. Load punched sheets directly onto the opened comb. Starting with the front of the document.

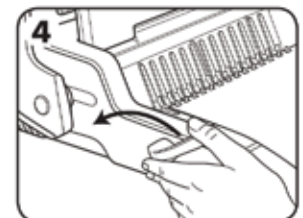

4. When all punched sheets are loaded onto the comb, push the comb lever backwards to close the comb and remove the bound document.

CORRECTING A BOUND DOCUMENT

Additional sheets may be included or removed at any time by opening and then closing the comb as previously described.

REMOVAL OF WASTE CLIPPINGS

The waste tray is located under the machine and is accessed from the right side. For best results empty the tray regularly.

STORAGE

Lower the punch handle to the horizontal position. Lower the lid.

TROUBLESHOOTING

Problem	Cause	Solution
Punched holes are not central	Edge guide not set	Adjust edge guide to correct paper or cover size.
Machine will not punch	Blockage	Check waste tray is empty. Check for blockage to paper entry.
Punch holes are not parallel to edge.	Debris is stuck below dies.	Take stiff cardboard and slide into the paper entry. Move the cardboard sideways to release any stray clippings into the waste tray.
Partial holes	Sheets not correctly aligned to punch pattern.	Adjust edge guide and test punch scrap sheets until correct
Damaged hole edges	Possibly overloading the machine	Punch plastic covers with paper sheets. Reduce number of sheets being punched.
Waste tray leaks	Waste tray is not correctly inserted or 'burst feature' has activated	Check waste tray is empty and 'burst feature' is closed.